



# User's Manual

**8-/16-port Combo LCD KVM**

**8-/16-port Combo IP LCD KVM**

▶ **IKVM/KVM-210 M Series**

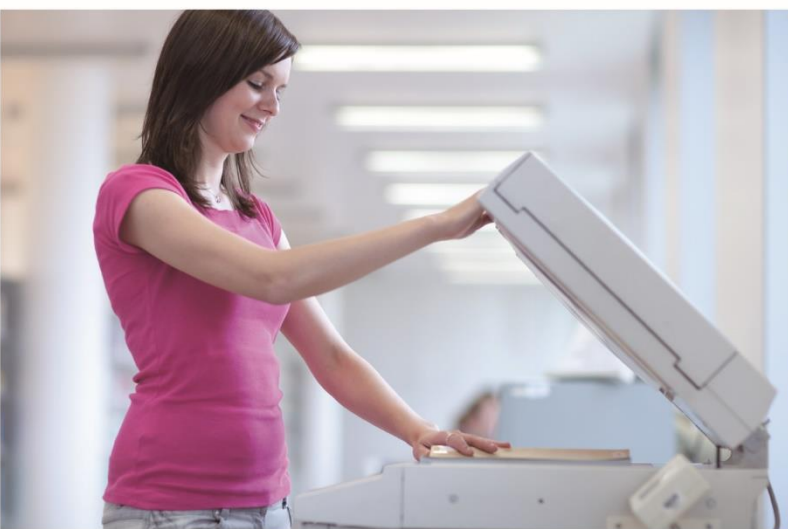

## **Copyright**

Copyright © 2017 by PLANET Technology Corp. All rights reserved. No part of this publication may be reproduced, transmitted, transcribed, stored in a retrieval system, or translated into any language or computer language, in any form or by any means, electronic, mechanical, magnetic, optical, chemical, manual or otherwise, without the prior written permission of PLANET.

PLANET makes no representations or warranties, either expressed or implied, with respect to the contents hereof and specifically disclaims any warranties, merchantability or fitness for any particular purpose. Any software described in this manual is sold or licensed "as is". Should the programs prove defective following their purchase, the buyer (and not PLANET, its distributor, or its dealer) assumes the entire cost of all necessary servicing, repair, and any incidental or consequential damages resulting from any defect in the software. Further, PLANET reserves the right to revise this publication and to make changes from time to time in the contents hereof without obligation to notify any person of such revision or changes.

All brand and product names mentioned in this manual are trademarks and/or registered trademarks of their respective holders.

## **Federal Communication Commission Interference Statement**

This equipment has been tested and found to comply with the limits for a Class B digital device, pursuant to Part 15 of FCC Rules. These limits are designed to provide reasonable protection against harmful interference in a residential installation. This equipment generates, uses, and can radiate radio frequency energy and, if not installed and used in accordance with the instructions, may cause harmful interference to radio communications. However, there is no guarantee that interference will not occur in a particular installation. If this equipment does cause harmful interference to radio or television reception, which can be determined by turning the equipment off and on, the user is encouraged to try to correct the interference by one or more of the following measures:

1. Reorient or relocate the receiving antenna.
2. Increase the separation between the equipment and receiver.
3. Connect the equipment into an outlet on a circuit different from that to which the receiver is connected.
4. Consult the dealer or an experienced radio technician for help.

## **FCC Caution**

To assure continued compliance, use only shielded interface cables when connecting to computer or peripheral devices. Any changes or modifications not expressly approved by the party responsible for compliance could void the user's authority to operate the equipment.

This device complies with Part 15 of the FCC Rules. Operation is subject to the following two conditions:

(1) This device may not cause harmful interference, and (2) this device must accept any interference received, including interference that may cause undesired operation.

## **Federal Communication Commission (FCC) Radiation Exposure Statement**

This equipment complies with FCC radiation exposure set forth for an uncontrolled environment. In order to avoid the possibility of exceeding the FCC radio frequency exposure limits, human proximity to the antenna shall not be less than 20 cm (8 inches) during normal operation.

## **Safety**

This equipment is designed with the utmost care for the safety of those who install and use it. However, special attention must be paid to the dangers of electric shock and static electricity when working with electrical equipment. All guidelines of this and of the computer manufacture must therefore be allowed at all times to ensure the safe use of the equipment.

## **CE Mark Warning**

This is a Class B product. In a domestic environment, this product may cause radio interference, in which case the user may be required to take adequate measures.

## **WEEE Regulation**



To avoid the potential effects on the environment and human health as a result of the presence of hazardous substances in electrical and electronic equipment, end users of electrical and electronic equipment should understand the meaning of the crossed-out wheeled bin symbol. Do not dispose of WEEE as unsorted municipal waste and have to collect such WEEE separately.

## **Revision**

User's Manual of PLANET 8-/16-port Combo LCD KVM

Model: KVM-210-08M / KVM-210-16M / IKVM-210-08M / IKVM-210-16M

Rev: 2.00 (September, 2023)

Part No. EM-xKVM-210-xM Series\_v2.0.docx

# Table of Contents

<b>Chapter 1. Product Introduction</b> .....	5
1.1 Package Contents .....	5
1.2 Overview .....	6
1.3 Features .....	9
1.4 Specifications .....	10
<b>Chapter 2. Hardware Interface</b> .....	14
2.1 Physical Descriptions .....	14
2.2 Hardware Installation .....	17
<b>Chapter 3. Operations</b> .....	19
3.1 Manual Key .....	19
3.2 Switch Hotkey .....	19
3.3 OSD (On Screen Display) .....	20
3.3.1 GOTO .....	21
3.3.2 SCAN .....	21
3.3.3 LIST .....	22
3.3.4 QV (Quick View) .....	22
3.3.5 EDIT .....	23
3.3.6 SET .....	24
<b>Chapter 4. IPKVM Software (For IKVM Series)</b> .....	25
4.1 System Requirements .....	25
4.2 IPKVM Software Installation .....	25
<b>Chapter 5. Web-based Management (For IKVM Series)</b> .....	28
5.1 Mouse Settings .....	28
5.2 Network Connection .....	32
5.3 Web Management .....	34
5.3.1 Console .....	34
5.3.2 User .....	36
5.3.3 Log .....	37
5.3.4 Network .....	38
5.3.5 System .....	39
<b>Appendix A: Frequently Asked Questions</b> .....	40

# Chapter 1. Product Introduction

## 1.1 Package Contents

The package should contain the following:

- Combo LCD KVM Switch x 1
- Quick Start QR Code Sheet x 1
- KVM Cable x 1
- Rack-mounting Kit x 1
- Power Adapter x 1
- Power Cord x 1
- Stand Kit x 1
- M6 Screw x 12
- IP Module x 1(For IKVM Series)

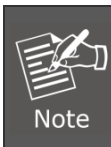

Note

If any of the above items are missing, please contact your seller immediately.

## 1.2 Overview

### Easy Switching, Efficient Management

PLANET KVM-210-08M/16M Combo VGA LCD KVM Switch features an integrated 17" LED-backlit LCD panel allowing access to and control up to 8/16 computers from a single console (keyboard, mouse and monitor). Simply use the supplied Combo VGA cable set to link the KVM-210-08M/16M to the console ports of your KVM Switch, regardless of the connected port interface -- USB or PS/2.

### Control All Your PCs via IP-based KVM (For IKVM Series)

PLANET IKVM-210-08M/16M Combo VGA LCD IP KVM Switch comes with a rack-mountable keyboard, 17" LCD and touchpad in a single console that occupies only 1U of rack space. From across the room, down the street or halfway around the globe, the IKVM-210-08M/16M can be accessed from any computer on the LAN, WAN or Internet. Easy to install and use, it's the optimal solution for controlling up to 8/16 computers/servers.

### Easy to Install

With the uniquely separate rail design, it helps to install the KVM console easily. Moreover, when there is a need to maintain the console, the administrator can easily uninstall the device without affecting the server above or below.

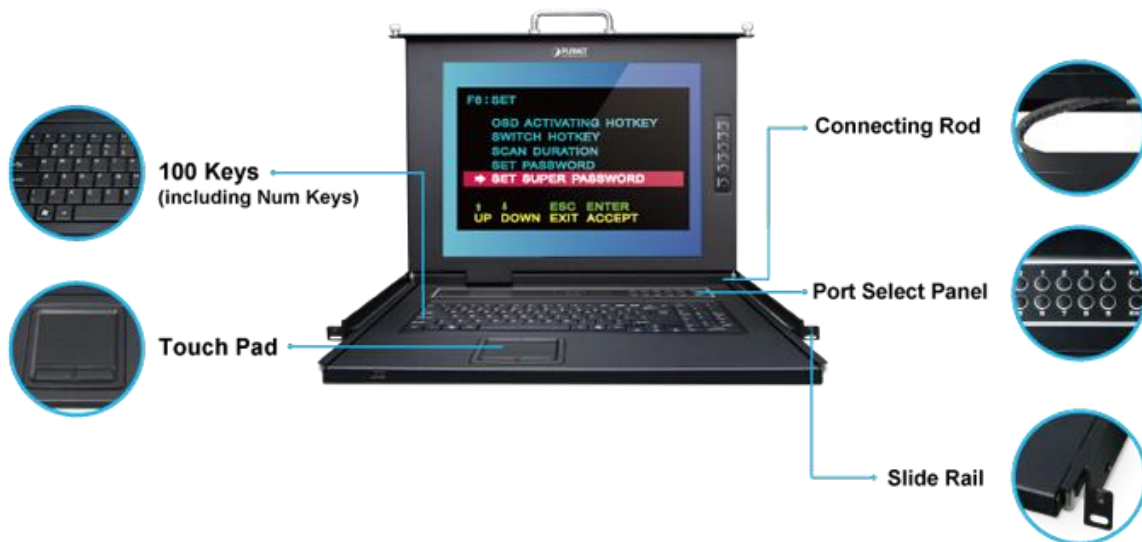

### Multiple Operating Systems Supported (For IKVM Series)

The IKVM-210-08M/16M is the most cost-effective and simple solution for controlling a group of PCs in the network. Multiple computers can be managed via only one single set of monitor, keyboard and mouse directly. No software drivers or system configuration are required. iMac, Power Mac and Sun systems are also supported.



### Remote Key Combination (For IKVM Series)

You could set the multiple key combinations at IKVM Series. When you open IKVM software at remote client, you could use these key combinations to control these local PCs with a different OS via the internet.



### Computer Switching

There are three convenient methods to access any computer connected to the installation:

- Port select button
- Hotkeys on keyboard
- OSD (on screen display) at local client and remote client

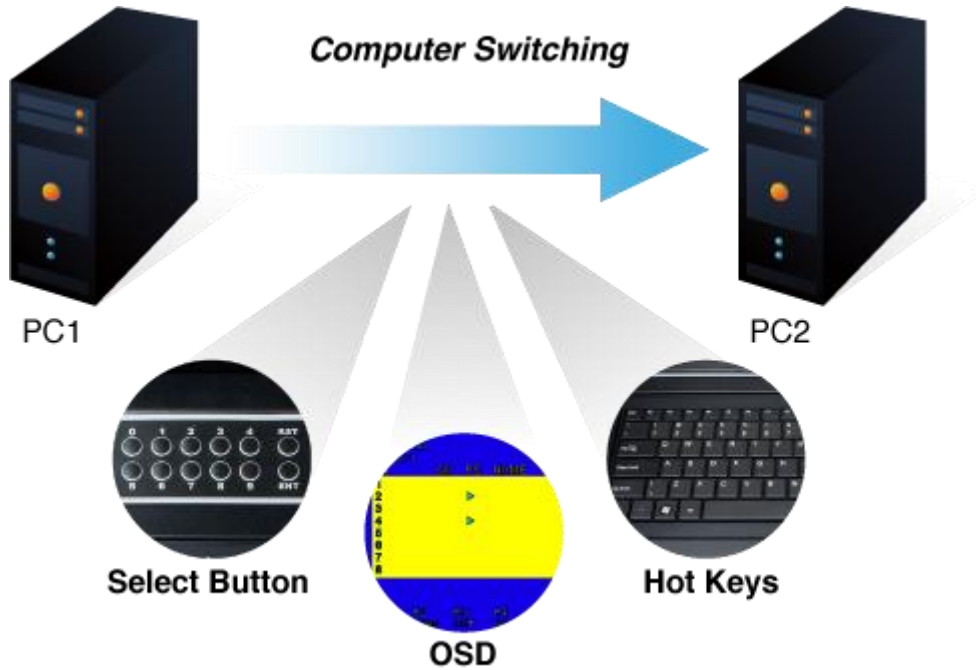

### Security Protection

Two level password security only authorizes up to one user and an administrator with a separate profile for each user. Data encryption options include AES, DES and 3DES, and they can be selected for keyboard, mouse and video signals.



### Powerful Mouse/Keyboard Support

In the present computer applications, a mouse has become an indispensable device. The IKVM/KVM-210 Series fully supports all models of PS/2 mice on the market. The xKVM also supports the PS/2 keyboard port of code set 1/2/3 and further allows you to use the xKVM for all kinds of servers, computers or their combination.



## 1.3 Features

### ➤ Hardware

- Integrated 17" LCD monitor and keyboard/touchpad module within 1U chassis
- Standalone machine controls up to 8/16 sets of computers
- Up to 2 levels can be cascaded and up to 64/256 computers can be controlled
- Port Select Panel status LEDs give a clear indication of the active computers
- Mouse touch board with two function buttons
- Full-size 100-key keyboard with integrated number pad
- Front panel with lock to prevent damage by accident

### ➤ Security

- Two-layer password security protection
- DES, AES and 3DES for data encryption (For IKVM Series)

### ➤ Management

- Auto scan mode for monitoring computers
- Requires no additional software or hardware
- Computer selection via Port Select Button, Hotkey and On Screen Display (OSD)
- Hot pluggable: Add or remove computers without having to power down the switch
- QVS (Quick View Setting): Quickly select your computer by naming or SN number

### ➤ Remote Access (For IKVM Series)

- Remotely control PC via TCP/IP and a built-in 10/100/1000Mbps Ethernet port
- High Video Quality: Resolution up to 1280 x 1024 (local side) or 1920 x 1080 (remote side)
- Sends the key combinations to a remote computer
- Administrator and multiple users with password protection
- Use of the absolute synchronistical technology of mouse to ensure the accuracy of the Windows operating system
- Expedient bandwidth control

### ➤ Compatibility

- Multiplatform support -- Windows, Linux and Sun
- Multibrowser support (IE, Chrome, Firefox) (For IKVM Series)
- Supports Microsoft Intellimouse, Logitech Net Mouse and other third-party's PS/2 mice

## 1.4 Specifications

### KVM-210 M Series Specifications

Product		KVM-210-08M	KVM-210-16M
<b>Hardware</b>			
Number of Ports		8 D-sub ports (15-pin)	16 D-sub ports (15-pin)
Maximum		64 by 2-tier star-type cascading (KVM-210-08 x 8)	256 by 2-tier star-type cascading (KVM-210-16 x 16)
PC Ports	Keyboard	USB Type A female head	
	Mouse	USB Type A female head	
	Video	8 D-sub ports (15 female)	16 D-sub ports (15 female)
Port Select Panel	Number Key	10	
	Reset	1	
	Enter	1	
	LED	8 (Red)	16 (Red)
	Segment Display	1	
LCD Panel	Monitor	17" SXGA Color TFT-LCD	
	Video Resolution	1280 x 1024 @ 60HZ Local	
	Pixel Pitch	0.264 x 0.264 mm	
	Support Color	16.7M colors	
	Contrast Ratio	1000:1	
	Backlight	LED	
LCD Button		6	
Console USB Hub Ports		3 USB 2.0 Type A female	
Keyboard		100-key chocolate ultra-thin keyboard	
Touch Pad		1	
Housing		Metal	
Dimensions (W x D x H)		445 x 544 x 45mm	
Weight		10.23 kg	10.43 kg
Power Requirement		12V DC, 4A	
Installation		1U rack-mountable	

<b>Management</b>	
PC Selection	Port select button Hotkeys on keyboard OSD (on screen display)
Scan Interval	3~60 seconds
Security	User password and super password
<b>Environment &amp; Certification</b>	
Operating Temperature	0 ~ 50 degrees C
Storage Temperature	-20 ~ 60 degrees C
Operating Humidity	0-80% RH, no coagulation
Regulatory	CE, FCC

### IKVM-210 M Series Specifications

Product		IKVM-210-08M	IKVM-210-16M
<b>Hardware</b>			
Number of Ports		8 D-sub ports (15-pin)	16 D-sub ports (15-pin)
Maximum		64 by 2-tier star-type cascading (KVM-210-08 x 8)	256 by 2-tier star-type cascading (KVM-210-16 x 16)
PC Ports	Keyboard	USB Type A female head	
	Mouse	USB Type A female head	
	Video	8 D-sub ports (15 female)	16 D-sub ports (15 female)
Port Select Panel	Number Key	10	
	Reset	1	
	Enter	1	
	LED	8 (Red)	16 (Red)
	Segment Display	1	
LCD Panel	Monitor	17" SXGA Color TFT-LCD	
	Video Resolution	1280 x 1024 @ 60HZ Local	
	Pixel Pitch	0.264 x 0.264 mm	
	Support Color	16.7M colors	
	Contrast Ratio	1000:1	
	Backlight	LED	
LCD Button		6	
Console USB Hub Ports		3 USB 2.0 Type A female	
Remote Console		1 RJ45 port for 10/100/1000BASE-T	
Video Resolution		Local side: 1280 x 1024 (max) Remote side: 1920 x 1080 (max)	
Keyboard		100-key chocolate ultra-thin keyboard	
Touch Pad		1	
Housing		Metal	
Dimensions (W x D x H)		445 x 544 x 45mm	
Weight		10.24 kg	10.44 kg
Power Requirement		12V DC, 4A	
Installation		1U rack-mountable	

<b>Management</b>	
Supported Protocol	TCP, IP, HTTP
Client Software	IPKVM Software
PC Selection	Port select button Hotkeys on keyboard OSD (on screen display)
Scan Interval	3~60 seconds
Security	User password and super password DES, AES and 3DES
<b>Environment &amp; Certification</b>	
Operating Temperature	0 ~ 50 degrees C
Storage Temperature	-20 ~ 60 degrees C
Operating Humidity	0-80% RH, no coagulation
Regulatory	CE, FCC

## Chapter 2. Hardware Interface

### 2.1 Physical Descriptions

#### Control Platform

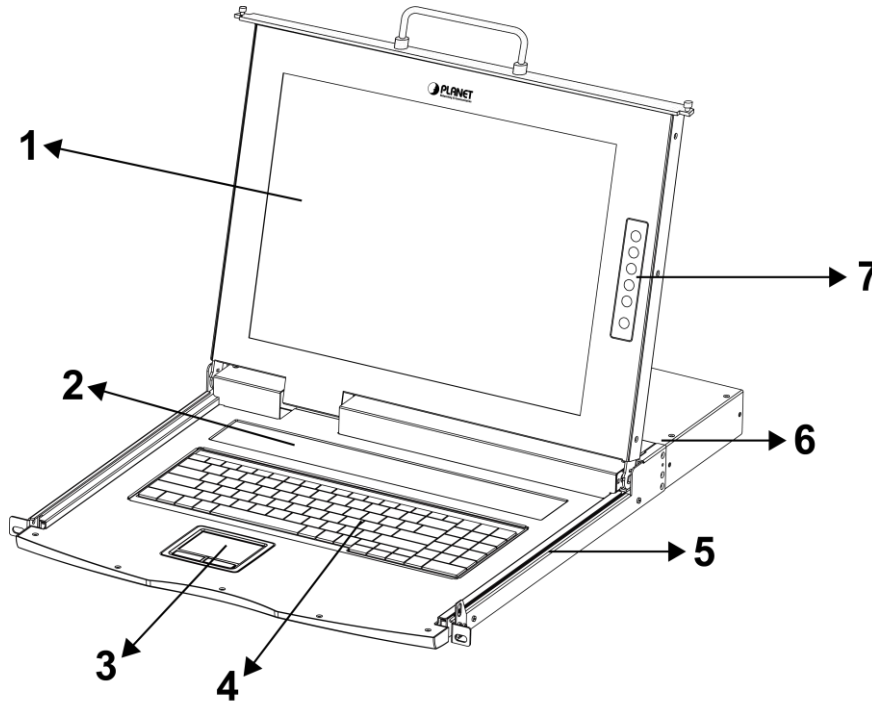

No.	Component	Function Description
1	LCD	17" LCD screen
2	Port Select Panel	Switch the Port Number and display the online port
3	Touchpad	Mouse Operation
4	Keyboard	Keyboard Operation
5	Slide Rail	Single Slide Rail
6	8-/16-port KVM	Modular KVM for 8/16 ports
7	LCD Panel OSD Buttons	Controls Display Required Quality

#### KVM-210 M Series Rear Panels

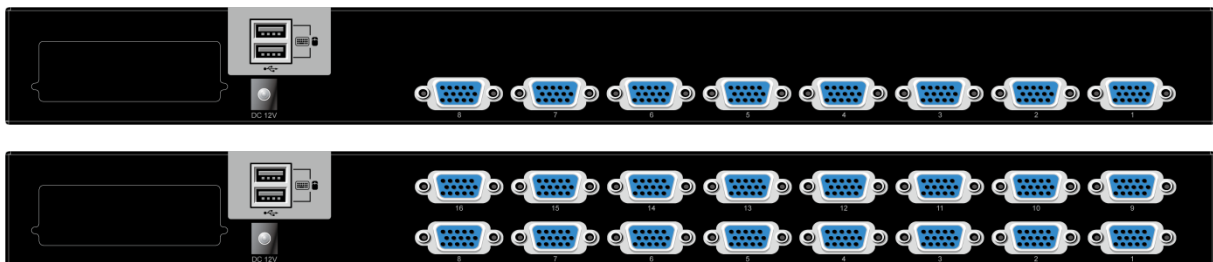

### IKVM-210 M Series Rear Panels

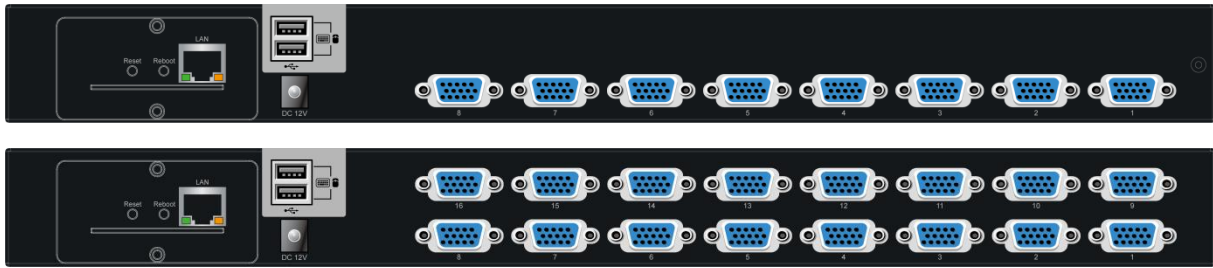

Interface	Description
Power Jack	<p>The input power is 12V DC.</p> <p><b>Note</b> Use the power adapter included in the package; otherwise, it may damage the unit and result in danger.</p>
USB Port	Plug external USB keyboard and mouse into this port.
Computer Port	Install the KVM cable connected to a PC here.

### Port Select Panel



Interface	Description
Online	If a corresponding LED number is on, it means the port is online. Otherwise, the port is off.
Select	The selected port number will display here in segment display.
RST	Detect the PS2/USB signal of port again.
ENT	User can select by pressing the number buttons and press "ENT" to confirm, then it will switch to the corresponding port. If that port is offline or the wrong number is pressed which is not included in display scope, there will be no response, but just keep the present status.

**IP Module**

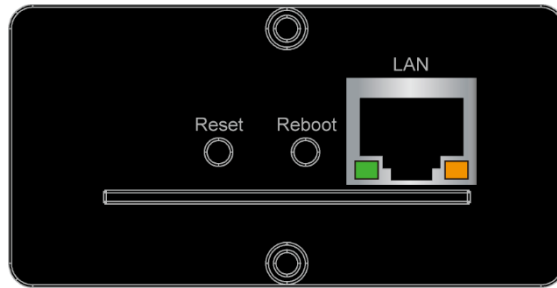

Interface	Description
LAN Port	One 10/100/1000BASE-T RJ45 auto-MDI/MDI-X port.
Reboot	Press and release to restart the system.
Reset	Press for <b>5 seconds</b> to reset to default.



## 2.2 Hardware Installation

The LCD KVM provides a standard 19-inch rack for the installation of devices. Please use the rack installation accessories attached with the product package. First install the accessories to the device and then the device to the rack.

**Step 1.** Screw the front flange to the rack first. Slide the bars with the rear flange towards the rack until the flanges make contact with the rack, then screw the rear flanges to the rack.

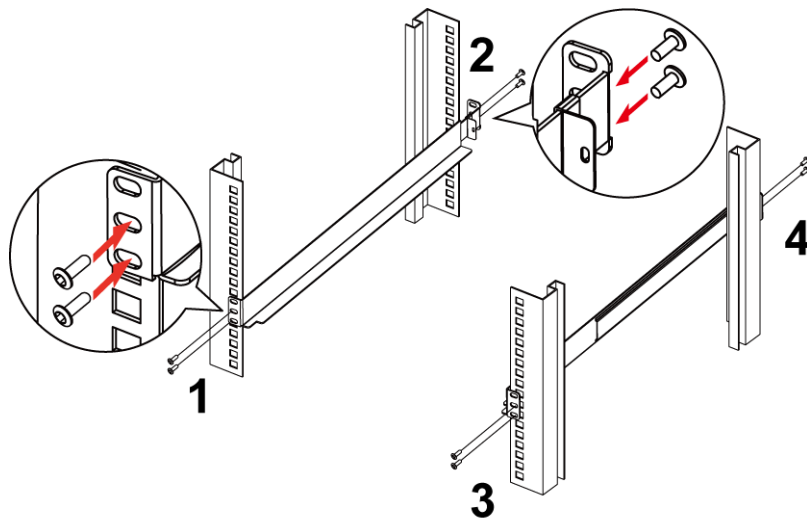

**Step 2.** Slide the switch onto the support flanges. Use the screws supplied with this package to loosely attach the front of the switch to the front of the rack.

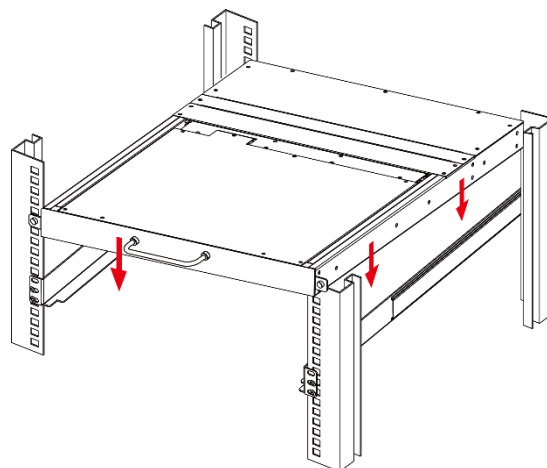

Note

- 1) You must use the screws supplied with the mounting brackets. Damage caused to the parts by using incorrect screws would invalidate your warranty.
- 2) Please make sure computer and switch KVM are turned off.

**Step 3.** Slide the rear attachment sliding brackets along the slide bars until they contact the rear of the switch.

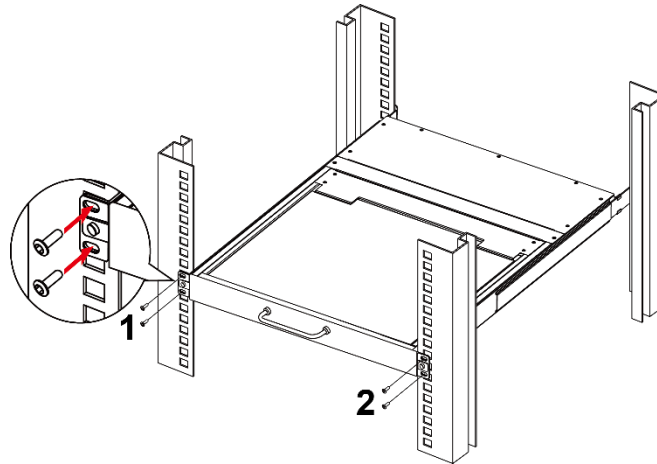

**Step 4.** Use the screws supplied with this package to attach the bars to the rear of the switch.

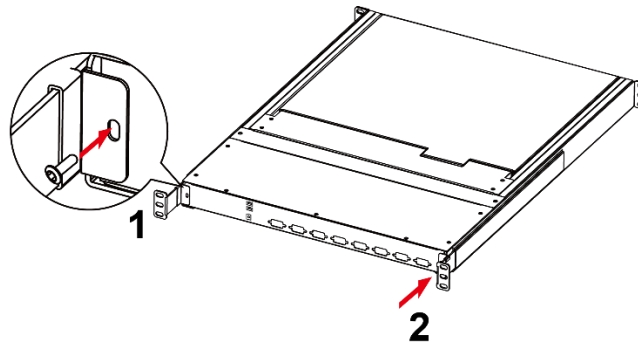

**Step 5.** Connect a PC to a computer port of the KVM, for example, port 1.

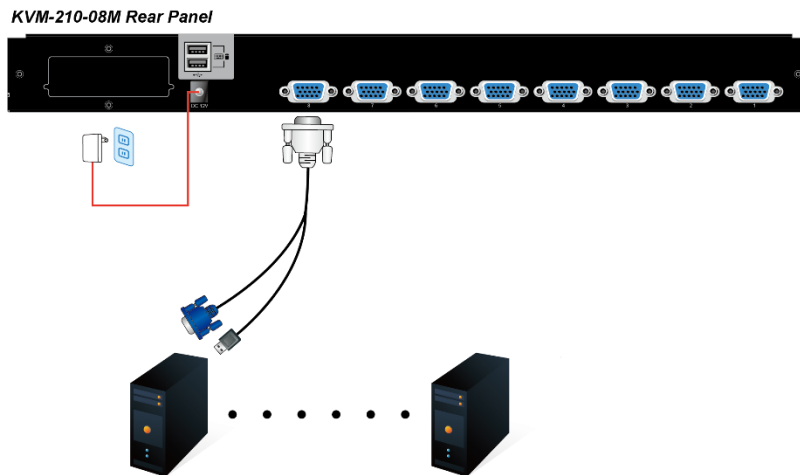

**Step 6.** Attach the power supply to the KVM unit and plug the other end into an electrical receptacle. Now you will see the LED for Port 1 light up. Switch on your monitor from the Port Select button.



KVM switch supports hot plug function, but please take necessary measures to avoid any occurrence of occasional short circuits caused by the pin of KVM connection cable contacts touching the hex screws.

## Chapter 3. Operations

There are three ways to switch PC. Please see the operation instructions below for more understanding.

### 3.1 Manual Key

You just need to press the **Port Select Button** on the front panel of the KVM. The **Selection LED (Green)** is **on**, indicating that you are switching to the corresponding port.



### 3.2 Switch Hotkey

You can use the numeric keys to enter the direct switch. For example, if you want to switch to PC port 2, you could press Ctrl + Ctrl + 2 and switch to PC port 2.

Scroll + Scroll + Num (Default setting)
Ctrl + Ctrl + Num
Alt + Alt + Num
Shift + Shift + Num

```

SWITCH HOTKEY

-> [ SCROLL ]+[ SCROLL ]+[ NUM ]+ENT
    [ CTRL ]+[ CTRL ]+[ NUM ]+ENT
    [ ALT ]+[ ALT ]+[ NUM ]+ENT
    [ SHIFT ]+[ SHIFT ]+[ NUM ]+ENT

↑   ↓   ESC   ENTER
UP  DOWN EXIT ACCEPT
  
```

### 3.3 OSD (On Screen Display)

Press the Ctrl on the keyboard twice to start the OSD. Use the key Up, Down and Enter keys on the keyboard to switch or directly move the mouse to the target PC, and then double-click the left button.

Ctrl + Ctrl (Default setting)
Scroll + Scroll
Alt + Alt
Shift + Shift

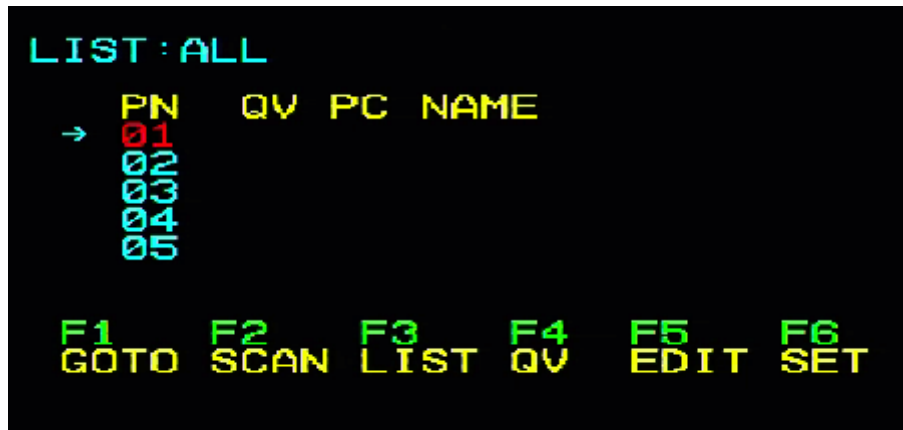

Parameters	Description
<b>PN</b>	This column lists the port numbers for all the CPU ports on the installation. The simplest method to access a particular computer is to move the highlight bar to it, and then press [Enter].
<b>QV</b>	If a port has been selected for Quick View scanning, an arrowhead symbol would display in this column to indicate so.
<b>PC</b>	The computers that are powered on and are on-line have an arrowhead symbol in this column to indicate so.
<b>NAME</b>	If a port has been given a name, its name would appear in this column.

### 3.3.1 GOTO

GOTO allows you to switch directly to a port either by keying in the port's name or its port number.



**NAME:** Move highlight bar to "NAME", press [**Enter**], input name of a port, and then press [**Enter**] to confirm.

**PN:** Move highlight bar to "PN", press [**Enter**], input port number, and then press [**Enter**] to switch. If the port number is invalid, it will remind the user to input again.

### 3.3.2 SCAN

The SCAN function can automatically scan from the currently selected port; the scan interval can be set by users. When scanning, a small window on the screen indicates the current port number. Press [**Space**] to stop scanning, and the KVM switches to the port last scanned.

### 3.3.3 LIST

The LIST function lets you broaden or narrow the scope of which port the OSD displays on the main screen.



Parameters	Description
ALL	Lists all of the ports on the installation.
QVIEW	Lists only the ports that have been selected as Quick View Ports.
POWERED ON	Lists only the ports that have their attached computers powered on.
POWERED ON + QVIEW	Lists only the ports that have their attached computers powered on and have been selected as Quick View Ports.
QVIEW + NAME	Lists only the ports that have been selected as Quick View Ports and have name.
NAME	Lists only the ports that have names.

### 3.3.4 QV (Quick View)

QV function can select port as Quick View. Move the highlight bar to a port and press [F4] to enable an icon of “up triangle” to appear. Press [F4] again and the icon disappears.

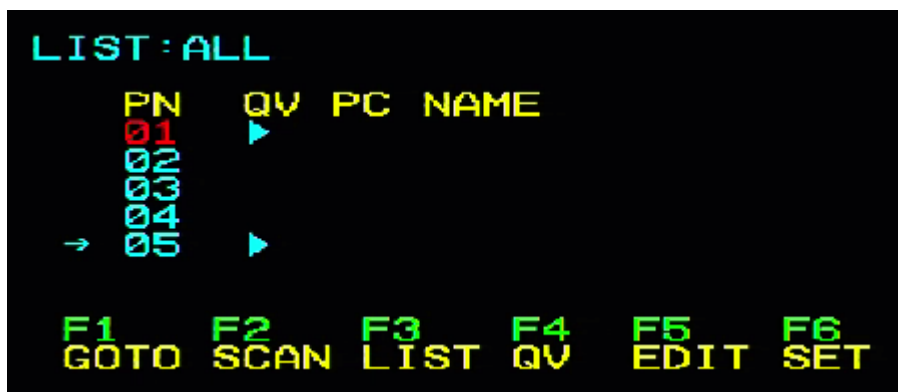

### 3.3.5 EDIT

EDIT function creates or edits the name of a port. Press [F5] and a pink edit box will appear on the screen. Input name and then press [Enter] to enable the port to be named, appearing on the screen.

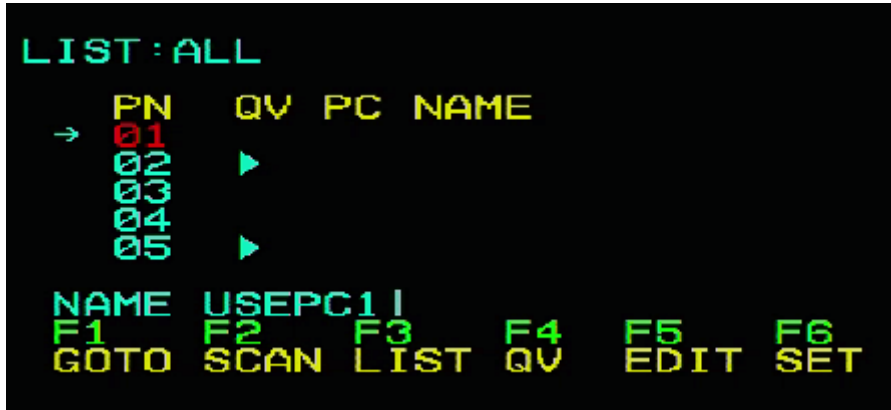

The maximum number of characters that can be input is 15, which will take effect when the "ENTER" confirmation is completed.

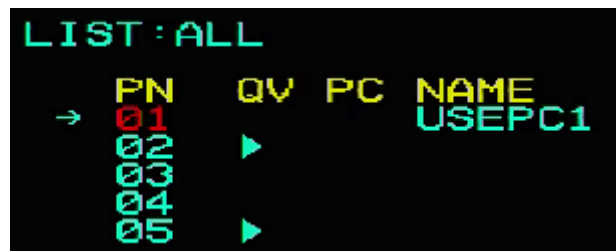

### 3.3.6 SET

SET function configures the OSD menu. Move the highlight bar to an option, and press **[Enter]** to enter a setting option.

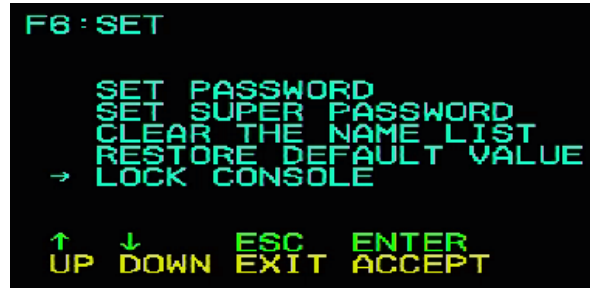
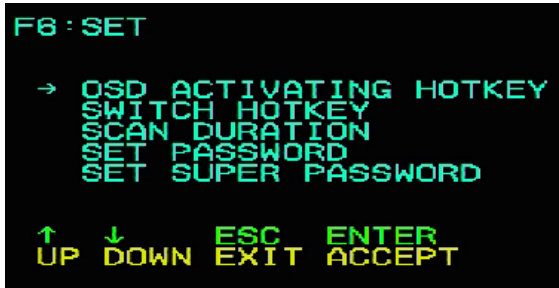

Parameters	Description
<b>OSD ACTIVATING HOTKEY</b>	Select OSD activating hotkey.
<b>SWITCH HOTKEY</b>	Select the switch hotkey to switch PC.
<b>SCAN DURATION</b>	Duration for scanning one port Options are 3 seconds, 5 seconds, 10 seconds, 15 seconds, 20 seconds, 30 seconds, 40 seconds, 60 seconds. Move the highlight bar to an option and press <b>[Enter]</b> to select it.
<b>SET PASSWORD</b>	Set new password. The password permission is for <b>user</b> . First enter old password, then enter new password and confirm it. The new password is set. If error occurs, the screen will remind users.
<b>SET SUPER PASSWORD</b>	Set new password. The password permission is for <b>administrator</b> . First enter old password, then enter new password and confirm it. The new password is set. If error occurs, the screen will remind users.
<b>CLEAR THE NAME LIST</b>	Clear the names of port list. You need to enter password to clear the names of port list.
<b>RESTORE DEFAULT VALUE</b>	Restore settings to default value. You need to enter password to Restore settings to default value.
<b>LOCK CONSOLE</b>	Lock the console. You cannot switch or scan after you lock the console (including switch by pressing the button on the panel or OSD). You need to enter password to set.



## Chapter 4. IPKVM Software (For IKVM Series)

PLANET IKVM Series provides an IPKVM utility to remotely control the server.

### 4.1 System Requirements

The following are required for further management:

<b>CPU:</b>	Intel Dual Core 2.0GHz or higher
<b>RAM:</b>	2GB or above recommended
<b>Video RAM:</b>	128MB or above recommended
<b>Operating System:</b>	Windows XP / 7 / 10
<b>Video Resolution:</b>	800 x 600, 1024 x 768, 1280 x 720, 1280 x 800, 1280 x 1024, 1920 x 1080
<b>Browser version</b>	<ul style="list-style-type: none"> <li>■ IE10.0 or higher</li> <li>■ Firefox 48.0.2 or higher</li> <li>■ Google Chrome 23.0.1271.97m or higher</li> </ul>



Note

1. The video resolution is based on the monitor and display card. Please select Full HD monitor and display card for IKVM Series.
2. The maximum video resolution of LCD is 1280 x 1024 with IKVM-210-08M/16M, so remote video solution only supports 1280 x 1024 or lower.

### 4.2 IPKVM Software Installation

Please refer to the steps below to install the IPKVM software.

**Step 1.** Insert the bundled CD disk into the CD-ROM drive to launch the autorun program. Once completed, a welcome screen will appear.

Click the “**Utility (IPKVM Software)**” button and the InstallShield Wizard dialog box will appear as shown below.



Note

If the PC or workstation is not equipped with CD-ROM driver, please download the IKVM software from the PLANET website.

<http://www.planet.com.tw/en/support/download.php?view=8184&key=IKVM-210#list>

**Step 2.** Once the Setup program starts running, please click the “**Next**” button for starting installation.

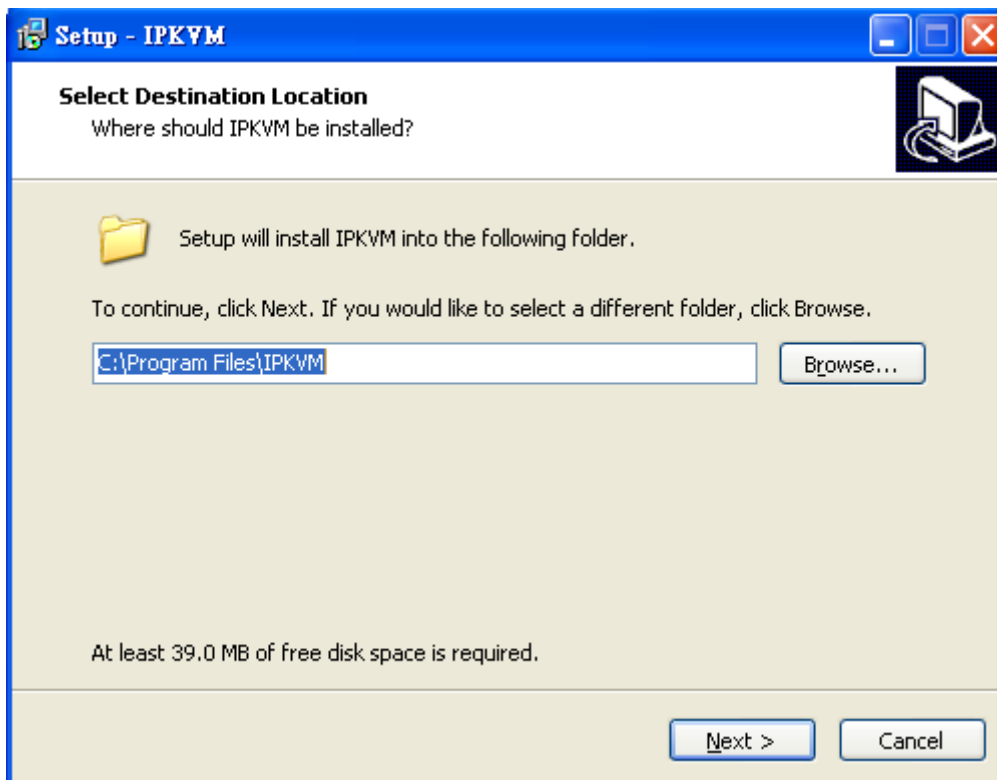

**Step 3.** Click “**Install**” for starting installation.

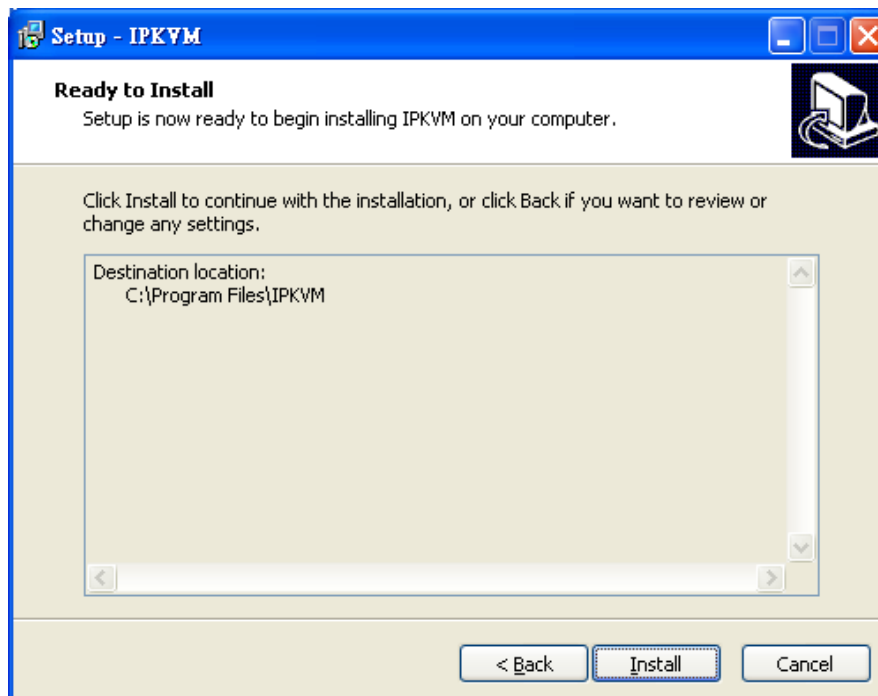

**Step 4.** Click the “**Finish**” button for completing the IPKVM Setup.

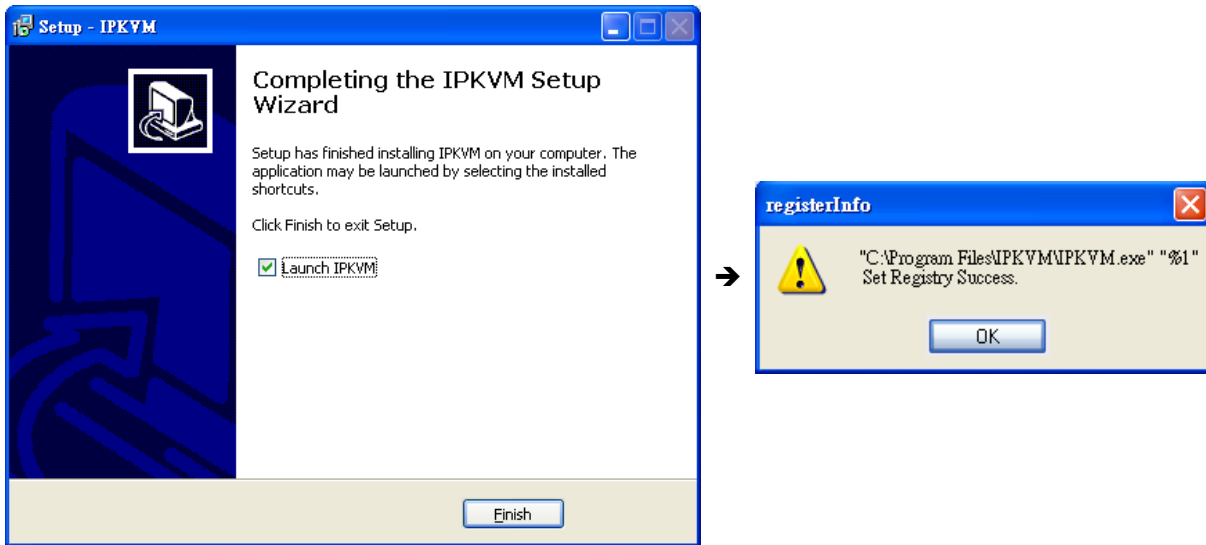

 Note	Please do not disable the <b>Launch IPKVM</b> . The IKVM needs registry to initiate the IPKVM software to enable to remotely control PC.
---	--

## Chapter 5. Web-based Management (For IKVM Series)

This section provides instructions about how to use the web interface to configure and control the PC remotely.

### 5.1 Mouse settings

A different OS has a different mouse setting. Please refer to the steps below to set the mouse setting of PC before logging to Web.

#### **Windows XP, Windows 2003 and Windows 2008 Settings**

To configure KVM target servers running Microsoft Windows XP, Windows 2003 or Windows 2008 operating system:

- i. Choose Start > Control Panel > Mouse.
- ii. Click the Pointer Options tab.
- iii. In the Motion group.
- iv. Set the mouse motion speed setting to exactly the middle speed.
- v. Disable the "Enhance pointer precision" option.
- vi. Disable the Snap To option.
- vii. Click OK.

#### **Windows Vista Settings**

To configure KVM target servers running Windows Vista operating system:

- i. Choose Start > Settings > Control Panel > Mouse.
- ii. Select "Advanced system settings" from the left navigation panel. The System Properties dialog opens.
- iii. Click the Pointer Options tab.
- iv. In the Motion group
- v. Set the mouse motion speed setting to exactly the middle speed.
- vi. Disable the "Enhanced pointer precision" option.
- vii. Click OK.

**✚ To configure KVM target servers running Windows 7 operating system:**

- i. Choose Start > Control Panel > Hardware and Sound > Mouse.
- ii. Click the Pointer Options tab.
- iii. In the Motion group
- iv. Set the mouse motion speed setting to exactly the middle speed.
- v. Disable the "Enhanced pointer precision" option.
- vi. Click OK.

**✚ Windows 2000 Settings**

To configure KVM target servers running Microsoft Windows 2000 operating system:

- i. Choose Start > Control Panel > Mouse.
- ii. Click the Motion tab.
- iii. Set the acceleration to None.
- iv. Set the mouse motion speed setting to exactly the middle speed.
- v. Click OK.

**✚ To configure KVM target servers running Linux (graphical user interface):**

- i. Choose Main Menu > Preferences > Mouse. The Mouse Preferences dialog appears.
- ii. Click the Motion tab.
- iii. Within the Speed group, set the Acceleration slider to the exact center.
- iv. Within the Speed group, set the Sensitivity towards low.
- v. Within the Drag & Drop group, set the Threshold towards small.
- vi. Close the Mouse Preferences dialog.



If these steps do not work, issue the `xset mouse 1 1` command as described in the Linux command line instructions.

**✚ To configure KVM target servers running Linux (command line):**

- i. Set the mouse acceleration to exactly 1 and set the threshold to exactly 1. Enter this command: `xset mouse 1 1`. This should be set for execution upon login.

**✚ To configure Red Hat servers using USB CIMs:**

- i. Locate the configuration file (usually `/etc/modules.conf` ) in your system. Using the editor of your choice, make sure that the alias `usb-controller` line in the `modules.conf` file is as follows:  
`alias usb-controller usb-uhci.`



Note

If there is another line using `usb-uhci` in the `/etc/modules.conf` file, it needs to be removed or commented out

- ii. Save the file.
- iii. Reboot the system in order for the changes to take effect.

**✚ Linux Settings (for Standard Mouse Mode)**

To configure KVM target servers running Linux (graphical user interface):

- i. Red Hat 5 users, choose Main Menu > Preferences > Mouse, Red Hat 4 users, choose System > Preferences > Mouse. The Mouse Preferences dialog appears.
- ii. Click on the Motion tab.
- iii. Within the Speed group, set the Acceleration slider to the exact center.
- iv. Within the Speed group, set the Sensitivity towards low.
- v. Within the Drag & Drop group, set the Threshold towards small.
- vi. Close the Mouse Preferences dialog.



Note

1. The settings below are optimized for Standard Mouse mode only.
2. If these steps do not work, issue the `xset mouse 1 1` command as described in the Linux command line instructions.

### **SUSE Linux 10.1 Settings**

To configure the mouse settings:

- i. Choose Desktop > Control Center. The Desktop Preferences dialog appears.
- ii. Click Mouse. The Mouse Preferences dialog appears.
- iii. Open the Motion tab.
- iv. Within the Speed group, set the Acceleration slider to the exact center position.
- v. Within the Speed group, set the Sensitivity slider to low.
- vi. Within the Drag & Drop group, set the Threshold slider to small.
- vii. Click Close.



Note

Do not attempt to synchronize the mouse at the SUSE Linux login prompt. You must be connected to the target server to synchronize the mouse cursor.

### **Sun Solaris Settings**

To configure KVM target servers running Sun Solaris:

- i. Set the mouse acceleration value to exactly 1 and the threshold to exactly 1. This can be performed from:  
The graphical user interface.  
To configure the mouse settings (Sun Solaris 10.1):
- ii. Choose Launcher. Application Manager - Desktop Controls opens.
- iii. Choose Mouse Style Manager. The Style Manager - Mouse dialog appears.
- iv. Set the Acceleration slider to 1.0.
- v. Set the Threshold slider to 1.0.
- vi. Click OK.

### **IBM AIX 5.3 Settings**

Follow these steps to configure KVM target servers running IBM. AIX. 5.3.

To configure the mouse

- i. Go to Launcher
- ii. Choose Style Manager.
- iii. Click Mouse. The Style Manager - Mouse dialog appears.
- iv. Use the sliders to set the Mouse acceleration to 1.0 and Threshold to 1.0.
- v. Click OK.

## 5.2 Network connection

**Step 1.** Connect manager PC to RJ45 LAN port to enable to remotely manage a PC. The default IP address of the IKVM-210 Series is **192.168.0.10**, then the manager PC should be set to **192.168.0.x** (where x is a number between 1 and 254, except 10), and the default subnet mask is 255.255.255.0.

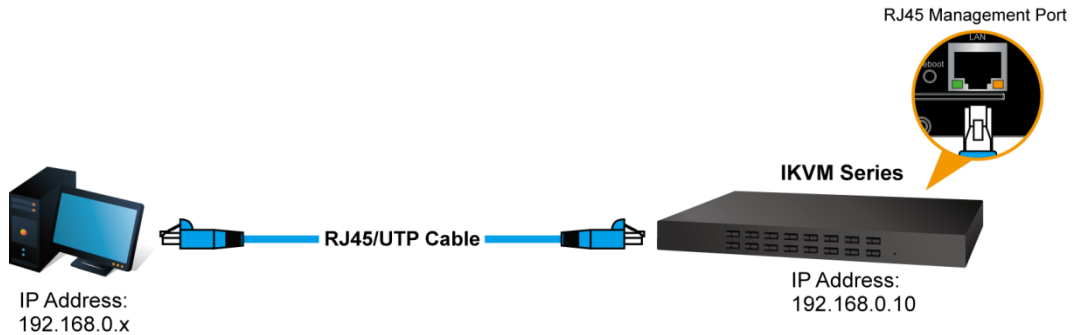

Default DHCP Client	N/A
Default IP Address	192.168.0.10
Default Port	80
Default Login User Name	admin
Default Login Password	admin
Search Tools	PLANET Smart Discovery Lite

**Step 2.** Login the Web Management. The username and password are both **admin**.

The screenshot shows the web management login interface. At the top left is the PLANET logo. Below it, there are two input fields: "User Name" with the text "admin" entered, and "Password" with six black dots. Below the password field is a "Login" button.



**Step 3.** If you cannot login the web, please use PLANET Smart Discovery Lite to search IKVM Series.

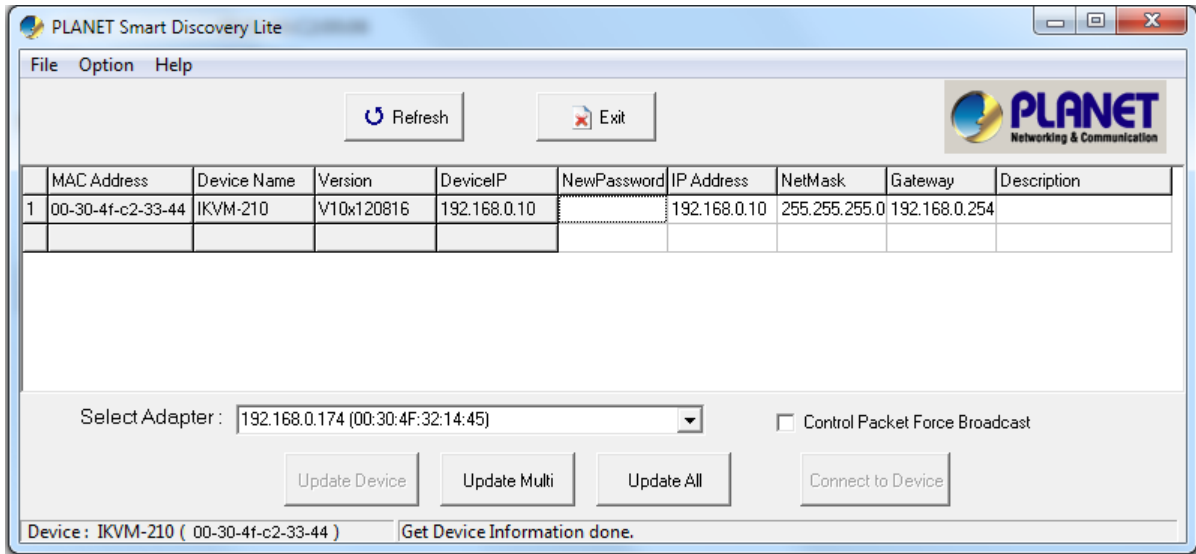





## 5.3 Web Management

### 5.3.1 Console

The Console is the redirected screen, keyboard and mouse of the remote host system that IP-KVM controls.





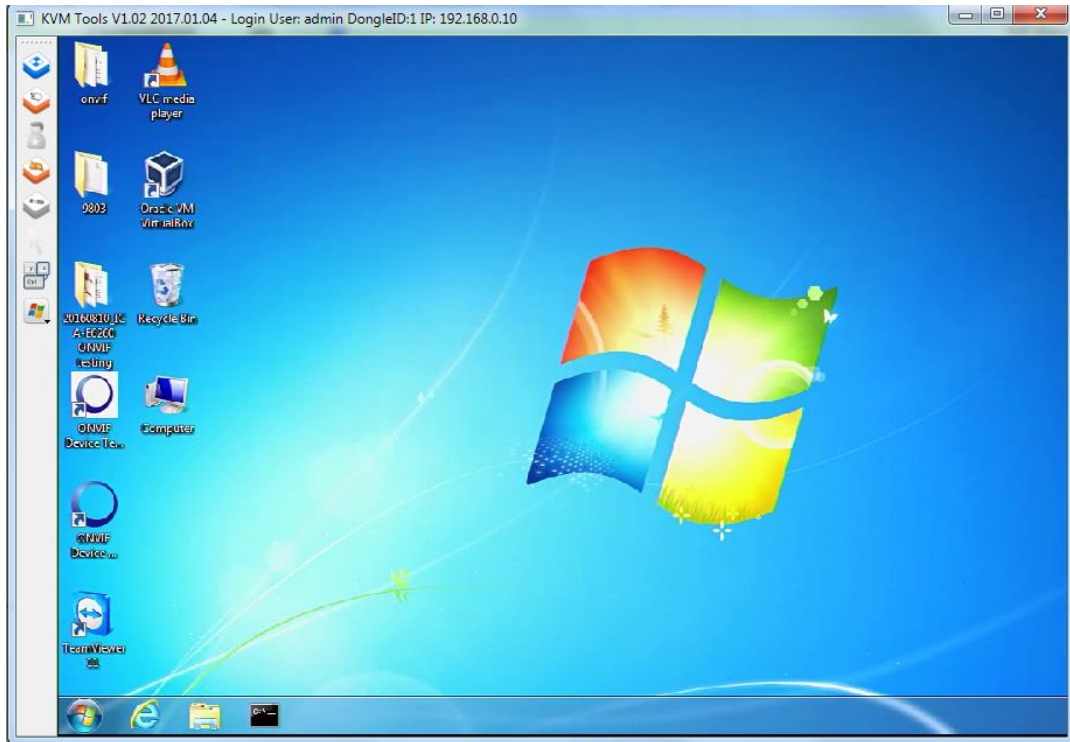

#### Online Console

Modify	PortID	Name	Type	Group	UID	Status	Client
	1	IKVM-210	usb		C1USB100000000002	idle	

Parameters	Description
 <b>Console</b>	Modify equipment description or register information  Name <input type="text" value="IKVM-210"/> Type <input type="text" value="usb"/> Group <input type="text"/> UID <input type="text" value="C1USB100000000002"/> Online Status <input type="text" value="idle"/> Position1 <input type="text"/> Position2 <input type="text"/> Department <input type="text"/> Memo <input type="text"/> Share Mode <input type="text" value="full share"/> Bit Stream <input type="text" value="2000"/> Frame Rate <input type="text" value="30"/> <div style="text-align: center;"> <input type="button" value="Save"/> <input type="button" value="Cancel"/> </div>
 <b>Client</b>	Open the remote console to control PC.

When you click “Client” and link the IPKVM.exe, then open the remote console. Please see the picture below for more understanding.









Parameters	Description
 <b>Full Screen</b>	Press the <b>Full Screen</b> to make display in full screen.
 <b>Align Mouse</b>	<p>After login, system will automatically calibrate mouse. If it fails, please click <b>Align Mouse</b> on the left to operate manually.</p> <div style="border: 1px solid black; padding: 5px;">   <b>Note</b> </div> <p>A different OS has a different mouse setting. Please refer to the user manual for setting the mouse first.</p>
 <b>Video Config</b>	Adjusting display area of screen.
 <b>Mouse Show</b>	The mouse can appear or hide by clicking it.
 <b>Set Key</b>	Remote hot-key edit button -- hot-key operation can be added in the pop-up dialog with the button clicked.
 <b>Show Key</b>	Choose the remote shortcut key directly to operate the controlled machine.

### 5.3.2 User



Mainly for user management, which includes three grades: Super Administrator (only one and couldn't be deleted), Administrator and User. User system includes three groups which can be made based on actual using condition. Higher grade user can add, delete or modify lower grade user. It can be done by modifying the tables as shown below.

#### Group and User

##### Group

Level	Group	Query	Modify
super	SuperAdmin		
administrator	Adminstrat		
normal	User		

##### User

Name	Group	Name2	Status	Memo	Query	Modify	Delete
admin	SuperAdmin	ADMIN	online				

**Insert user**

**Base Parameter**

Name	<input type="text"/>	Name2	<input type="text"/>
Password	<input type="text"/>	Home Addr	<input type="text"/>
Password Confirm	<input type="text"/>	Company Addr	<input type="text"/>
Group	<input type="text" value="User"/> ▼	Phone	<input type="text"/>
Memo	<input type="text"/>	Email	<input type="text"/>
		Memo2	<input type="text"/>

**Console Privilege**  
IKVM-210 Use Modify

Parameters	Description
<b>Super Administrator</b>	With all the permissions of setting operation
<b>Administrator</b>	Can edit the Console option setting of authorization Can add, delete, modify the user rights of the user operation; you can edit the level of user-related settings Can do the relevant inquiries of Log part. Cannot do the part of the set operation of Network and System
<b>User</b>	Can edit the Console option setting of authorization Cannot do any user rights to add and delete operations; can only do their own user-related settings Cannot do the part of the set operation of Network and System

### 5.3.3 Log

Many kinds of log queries and log details are supported as shown below.

#### Log query

UserName  Begin  End  Type

User Name	Time	Ip	Type	Query
-----------	------	----	------	-------

### 5.3.4 Network

Some information of server like IP address, UID, name, etc, which can be modified.

**Network**

**Base Parameter**

MAC                    00:50:56:C2:00:06

Name                    KMDVM2

Encrypt                3des

**Network Parameter**

IP                        192.168.0.10                    KeyMouse Port    5168

Subnet Mask            255.255.255.0                    Video Port        6968

Gateway                192.168.0.254                    WEB port         80

Parameters	Description
<b>MAC</b>	Display the Ethernet MAC address of the device. Note that user cannot change it.
<b>Encrypt</b>	DES, AES and 3DES.
<b>IP</b>	This address is a unique number that identifies a computer or device on the WAN or LAN. These numbers are usually shown in groups separated by periods, for example, 192.168.0.10.
<b>Subnet Mask</b>	Subnets allow network traffic between hosts to be separated based on the network's configuration. In IP networking, traffic takes the form of packets. IP subnets advance network security and performance to some level by organizing hosts into logical groups. Subnet masks contain four bytes and usually appear in the same "dotted decimal" data. For example, a very common subnet mask in its binary demonstration 11111111 11111111 11111111 00000000 will usually be shown in the corresponding, more readable form as 255.255.255.0.
<b>Gateway</b>	A gateway is a piece of software or hardware that passes information between networks. You'll see this term most often when you either log in to an Internet site or when you're transient email between different servers.
<b>KeyMouse Port</b>	Choose the KeyMouse port. The default value is 5168.
<b>Video Port</b>	Choose the Video port. The default value is 6968.
<b>Web Port</b>	Choose the Web port. The default value is 80.

### 5.3.5 System

**System Maintain**

Product      IKVM Series

Version     

Device Daytime   

Set Device Daytime         

Restart Device   

Update Firmware

Parameters	Description
<b>Version</b>	This information shows the software version in the device.
<b>Device Daytime</b>	Displays the date and time of the device.
<b>Set Device Daytime</b>	Click this option to set time and date manually.
<b>Restart</b>	The device is restarted without changing any of the settings.
<b>Update Firmware</b>	To update the firmware online, click " <b>Browse...</b> " to select the firmware. Then click "Update" to proceed.

## Appendix A: Frequently Asked Questions

### Q1. [KVM-210-08/KVM-210-16] What should we do if the keyboard/mouse has no response?

- 1) Reinstall the keyboard/mouse by unplugging the keyboard/mouse from the control end and then plugging it back.
- 2) Reboot the PC.
- 3) In the Auto Scan mode, press [Esc] to exit.
- 4) If this issue continues, please hold the reset button for about 5 seconds to load default.
- 5) Try another keyboard/mouse



Note

If you are using a special mouse, we recommend you to install the mouse driver provided by the original manufacturer to maximize its functionality.

### Q2. [KVM-210-08/KVM-210-16] What should we do if the OSD does not display normally?

Please check the settings below to solve this issue:

- 1) Check whether the power adapter is the right one or not. The input power is 9V DC, 1A.
- 2) If the setting for the resolution exceeds 2048 x 1536, 350MHz, then set the resolution within the specified range.
- 3) If the KVM switch is a standalone, then power off the PC. Unplug the special cable of the KVM switch and then power on the KVM switch. Connect the special cable of the KVM switch and power on the PC.
- 4) If the KVM switch is connected in series, then power off the PC. Unplug the special cable of the KVM switch. Power on the master KVM switch and then start the slave KVM switch. Connect the special cable to the KVM switch and power on the PC.

### Q3: [KVM-210-08/KVM-210-16] What should we do if there is a video problem?

Please check the settings below to solve this issue:

- 1) Check whether or not the setting of the resolution is too high. The maximum video resolution is up to 2048 x 1536, 350MHz.
- 2) The quality of cable is not good enough. Please use high-quality Smart View cables.

### Q4. [KVM-210-08/KVM-210-16] There are foggy images on the external monitor. Why?

The distance between the external console and the KVM-210-08/KVM-210-16 is too long. The maximum VGA cable distance should not exceed 20m and, in some cases, may need to be shorter. Replace the VGA cable with the one that is appropriately short.



**Q5. [IKVM-210-08/IKVM-210-16] Why does the remote console cannot display the screen at Full HD?**

Please check the settings below to solve this issue:

- 1) Please check whether the cable from the switch to the computer is properly connected.
- 2) IKVM will detect the video resolution of LCD at console port. If the LCD cannot support Full HD that the remote console cannot display, please replace another Full HD LCD.

**Q6. [IKVM-210-08/IKVM-210-16] What's the maximum number of users? How many users can be online at the same time?**

The maximum is 50 users. Five users can be online at the same time.

**Q7. [xKVM-210-xM] How can we switch to a specific PC on the cascaded KVM-210-08/KVM-210-16?**

- 1) Firstly, switch to the appropriate port for the cascaded KVM-210-08/KVM-210-16.
- 2) You can configure a SWITCH HOTKEY to directly switch to the desired PC.
- 3) Keep in mind that this SWITCH HOTKEY should not be the same as the xKVM-210-xM HOTKEY.